

**Note to other teachers and users of these slides:** We would be delighted if you found our material useful for giving your own lectures. Feel free to use these slides verbatim, or to modify them to fit your own needs. If you make use of a significant portion of these slides in your own lecture, please include this message, or a link to our web site: <http://www.mmds.org>

# Clustering

CS246: Mining Massive Datasets  
Jure Leskovec, Stanford University  
Mina Ghashami, Stanford University  
<http://cs246.stanford.edu>



# High Dimensional Data

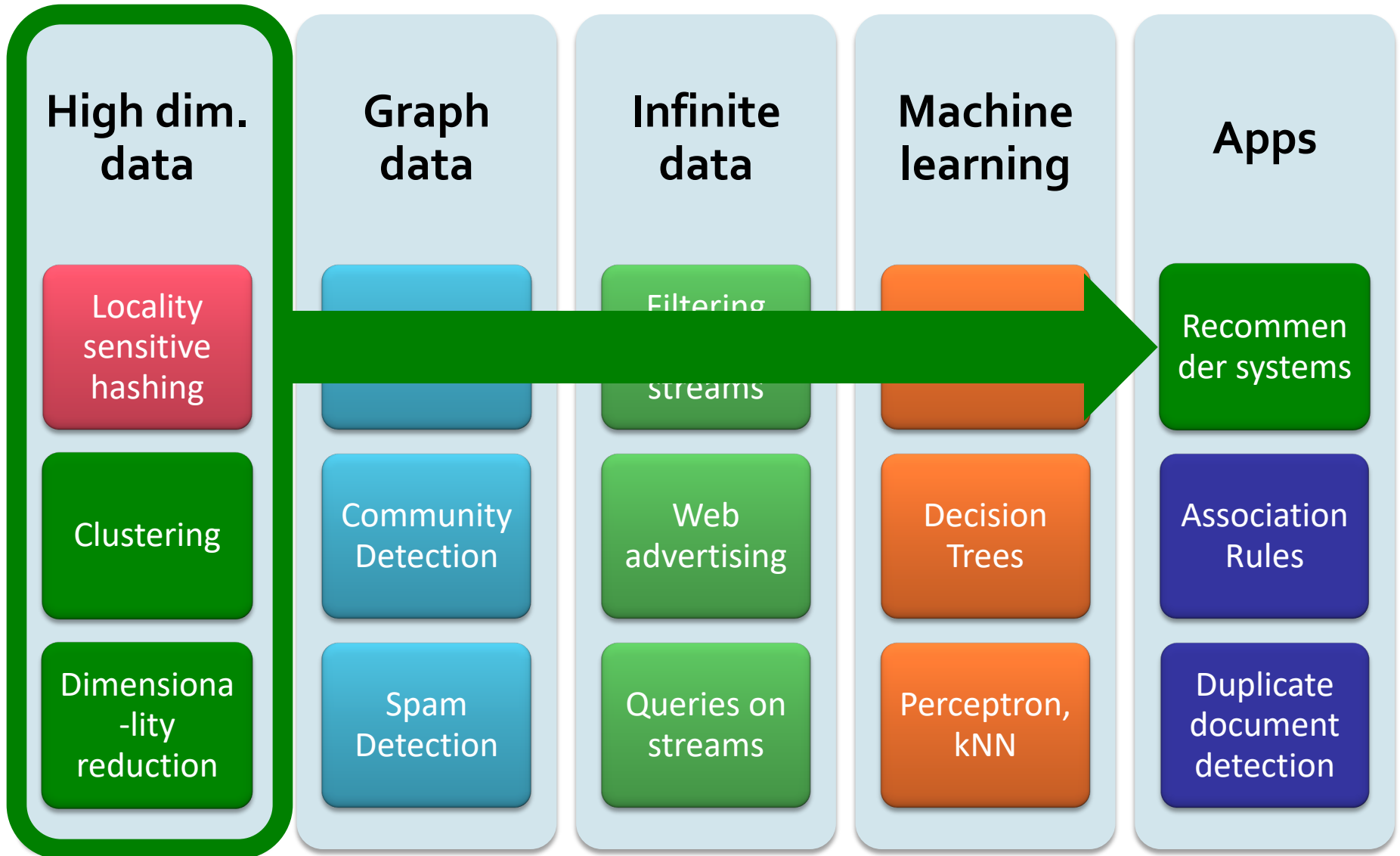

# The Problem of Clustering

- Given a **set of points**, with a notion of **distance** between points, **group the points** into some number of *clusters*, so that
  - Members of the same cluster are close/similar to each other
  - Members of different clusters are dissimilar
- **Usually:**
  - Points are in a high-dimensional space
  - Similarity is defined using a distance measure
    - Euclidean, Cosine, Jaccard, edit distance, ...

# Example: Clusters & Outliers

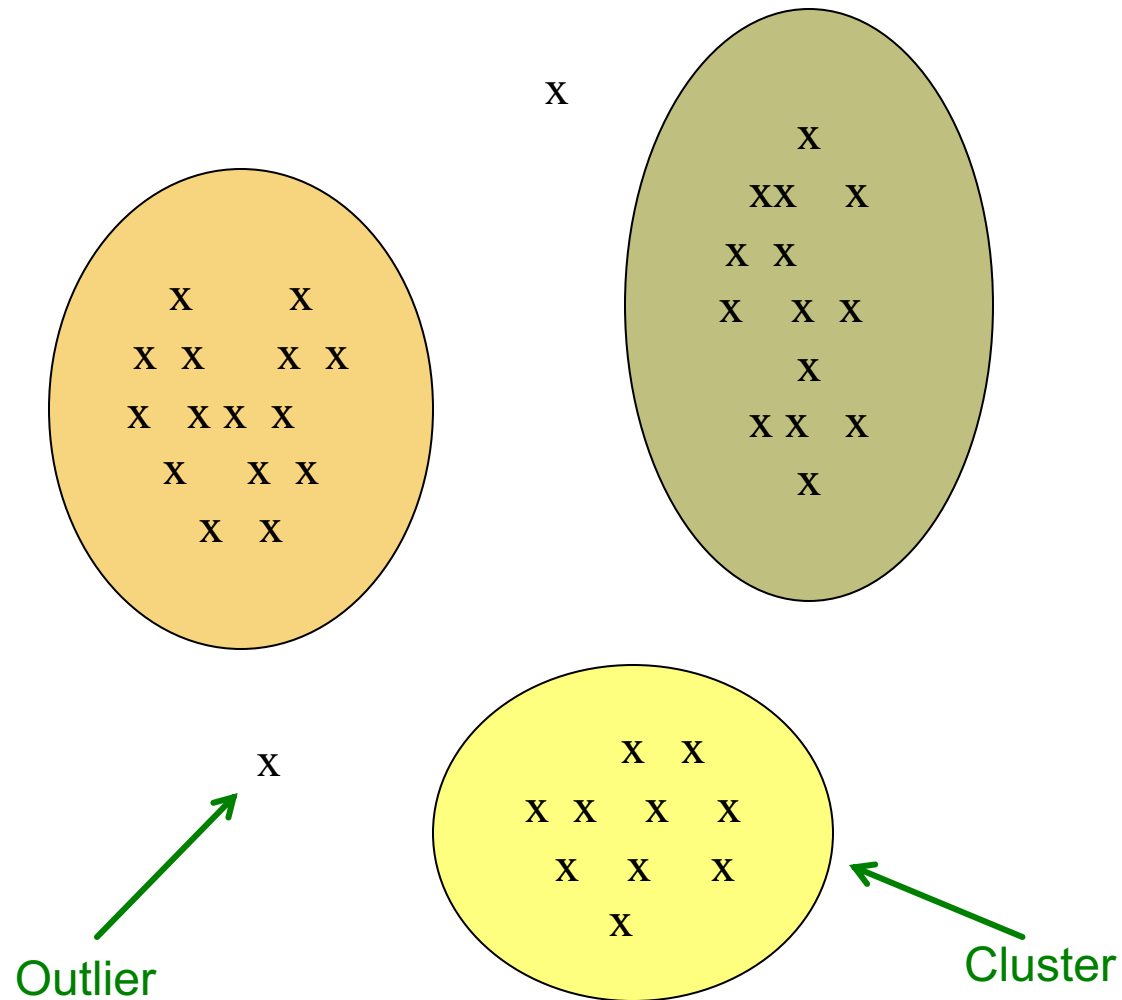

# Clustering Problem: Galaxies

- A catalog of 2 billion “sky objects” represents objects by their radiation in 7 dimensions (frequency bands)
- **Problem:** Cluster similar objects, e.g., galaxies, nearby stars, quasars, etc.
- Sloan Digital Sky Survey



# Clustering Problem: Music CDs

- **Intuitively:** Music can be divided into categories, and customers prefer a few genres
  - But what are categories really?
- Represent a CD by a set of customers who bought it
- Similar CDs have similar sets of customers, and vice-versa

# Clustering Problem: Music CDs

## Space of all CDs:

- Think of a space with one dim. for each customer
  - Values in a dimension may be 0 or 1 only
  - A CD is a “point” in this space  $(x_1, x_2, \dots, x_d)$ , where  $x_i = 1$  iff the  $i^{\text{th}}$  customer bought the CD
- For Amazon, the dimension is tens of millions
- **Task:** Find clusters of similar CDs

# Clustering Problem: Documents

## Finding topics:

- Represent a document by a vector  $(x_1, x_2, \dots, x_k)$ , where  $x_i = 1$  iff the  $i^{\text{th}}$  word (in some order) appears in the document
- **Documents with similar sets of words may be about the same topic**



# Cosine, Jaccard, and Euclidean

- **We have a choice when we think of documents as sets of words or shingles:**
  - **as vectors:** Measure similarity by the **cosine distance**
  - **as sets:** Measure similarity by the **Jaccard distance**
  - **as points:** Measure similarity by **Euclidean distance**

# Clustering is a hard problem!

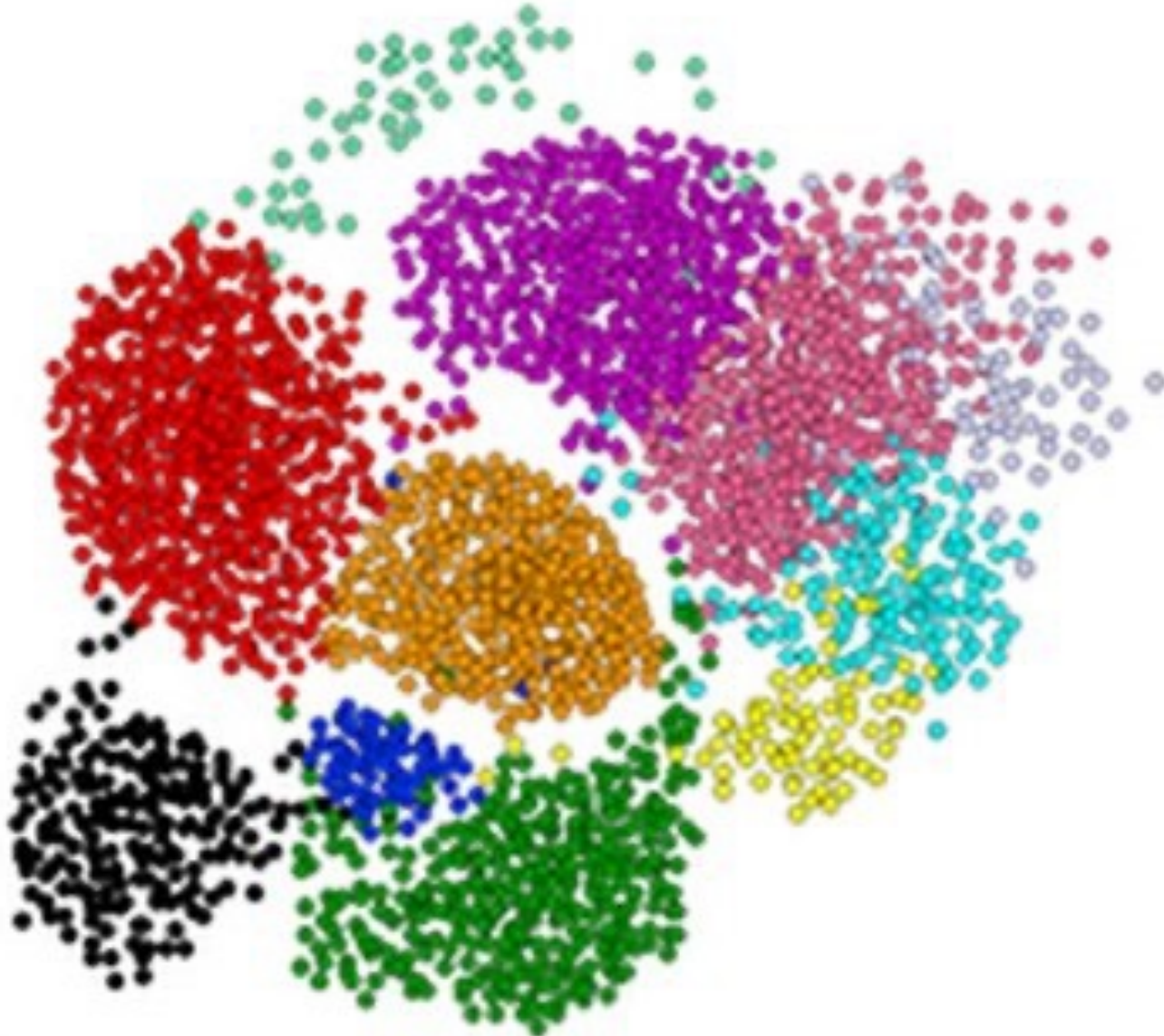

# Why is it hard?

- Clustering in two dimensions looks easy
- Clustering small amounts of data looks easy
  
- Many applications involve not 2, but 10 or 10,000 dimensions
- **High-dimensional spaces look different:**  
Almost all pairs of points are very far from each other --> **The Curse of Dimensionality!**

# Curse of Dimensionality

- Assume data lives in  $[0,1]^d$
- To capture a neighborhood which represents a fraction  $s$  of the hypercube volume, we need the edge length to be  $s^{1/d}$ 
  - $s = 0.1, d = 10, s^{1/d} = 0.8$
  - $s = 0.01, d = 10, s^{1/d} = 0.63$

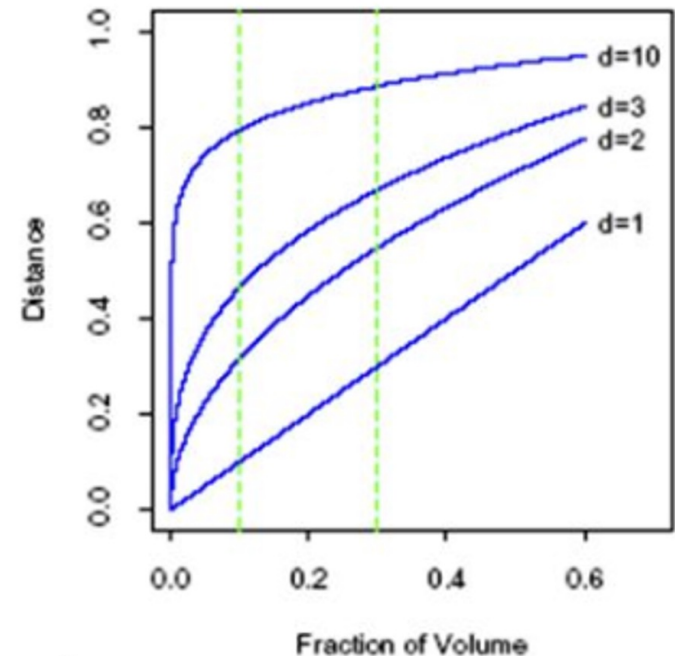

# Curse of Dimensionality

- Neighborhoods are no longer local
- All points are very far from each other
- Points in high-dim space are isolated
  - Volume of a hypercube with edge length  $r=0.1$  is  $0.1^d$
  - When  $d$  grows, it quickly becomes so small that the probability to capture points becomes very very small

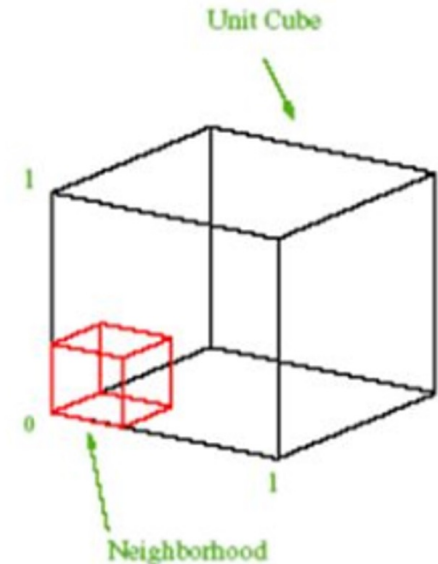

# Overview: Clustering Strategies (1)

Two group of methods:

- **Hierarchical:**

- **Agglomerative** (bottom up):

- Initially, each point is a cluster
- Repeatedly combine the two “nearest” clusters into one

- **Divisive** (top down):

- Start with one cluster and recursively split it

- **Point assignment:**

- Maintain a set of clusters
- Points belong to the “nearest” cluster

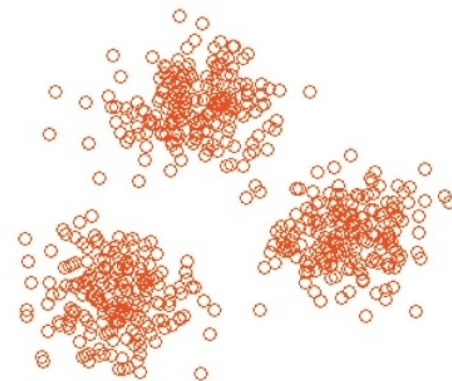
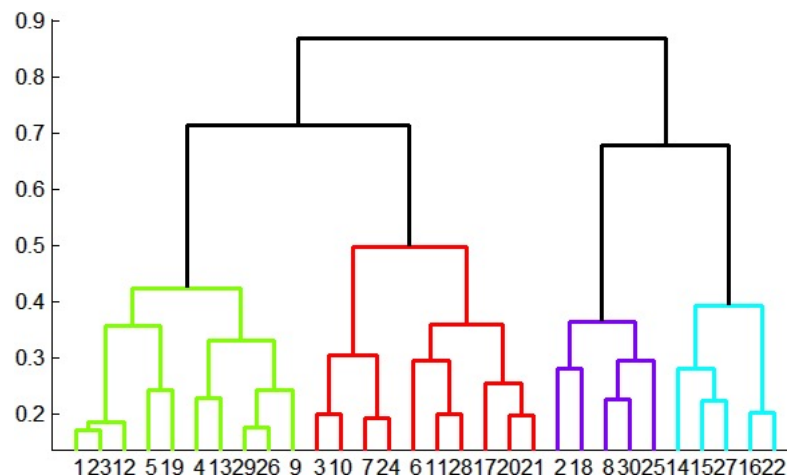

# Overview: Clustering Strategies (2)

- Is the space Euclidean or non-Euclidean?
- In Euclidean:
  - Points are vectors of real numbers, i.e. coordinates
  - It is possible to summarize a collection of points as their average. We call it *centroid*.
  - Distance measure: L2 norm, L1 norm
- In non-Euclidean:
  - There is no notion of location, and centroid
  - We summarize a collection of points differently
  - Distance measures: Jaccard, Hamming, cosine

# Overview: Clustering Strategies (3)

- Does the data fit in memory or does it reside on disk?
  - In-memory clustering is more straightforward
    - Example: K-means
  - Large-data clustering requires loading one batch of data at a time, cluster them in memory and keep summaries of clusters
    - Example: BFR, CURE



# Hierarchical vs point-assignment

- Point assignment good when clusters are nice, convex shapes:
- Hierarchical can win when shapes are weird:
  - Note both clusters have essentially the same centroid.

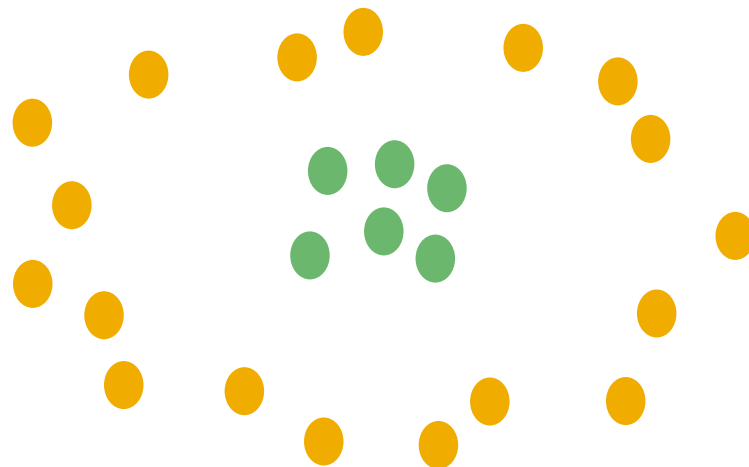
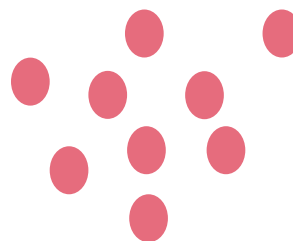

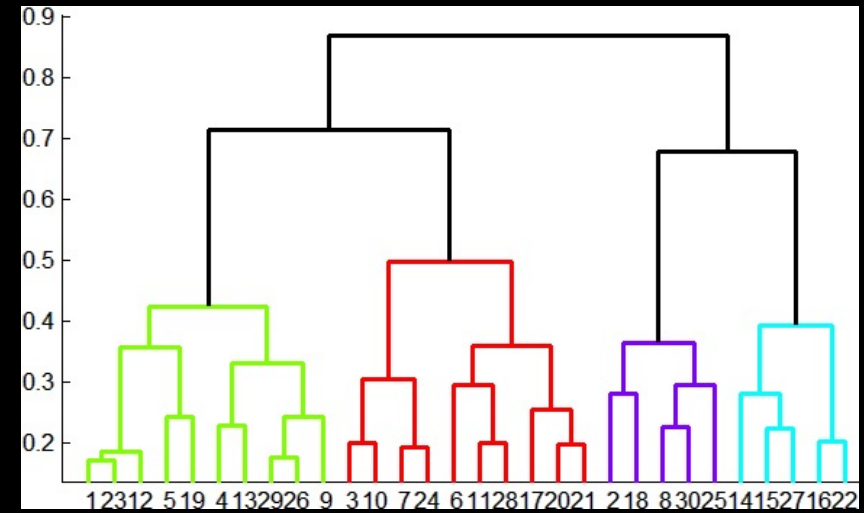

# Hierarchical Clustering

# Hierarchical Clustering

- **Key operation:**  
Repeatedly merge two “nearest” clusters
- **Three important questions:**
  - 1) How to represent a cluster?
  - 2) How to determine the nearness of clusters?
  - 3) When to stop merging clusters?

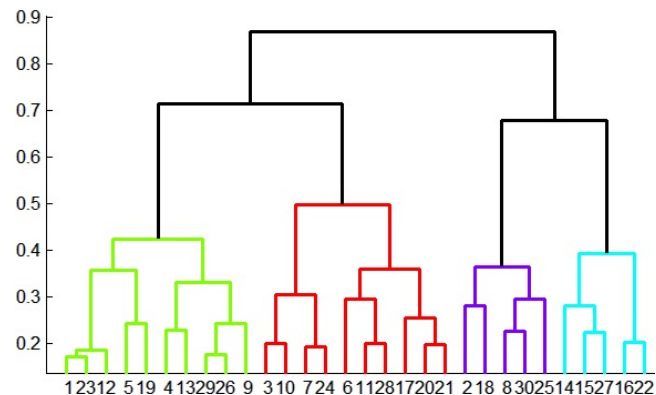

# Hierarchical Clustering: Euclidean

## In Euclidean case:

- **(1) How to represent a cluster of many points?**
  - As we merge clusters, we represent the “location” of each cluster by its *centroid* = average of its (data)points
- **(2) How to determine the nearness of clusters?**
  - Measure cluster distances by distances of centroids
  - Merge two clusters with the shortest distance

# Example: Hierarchical clustering

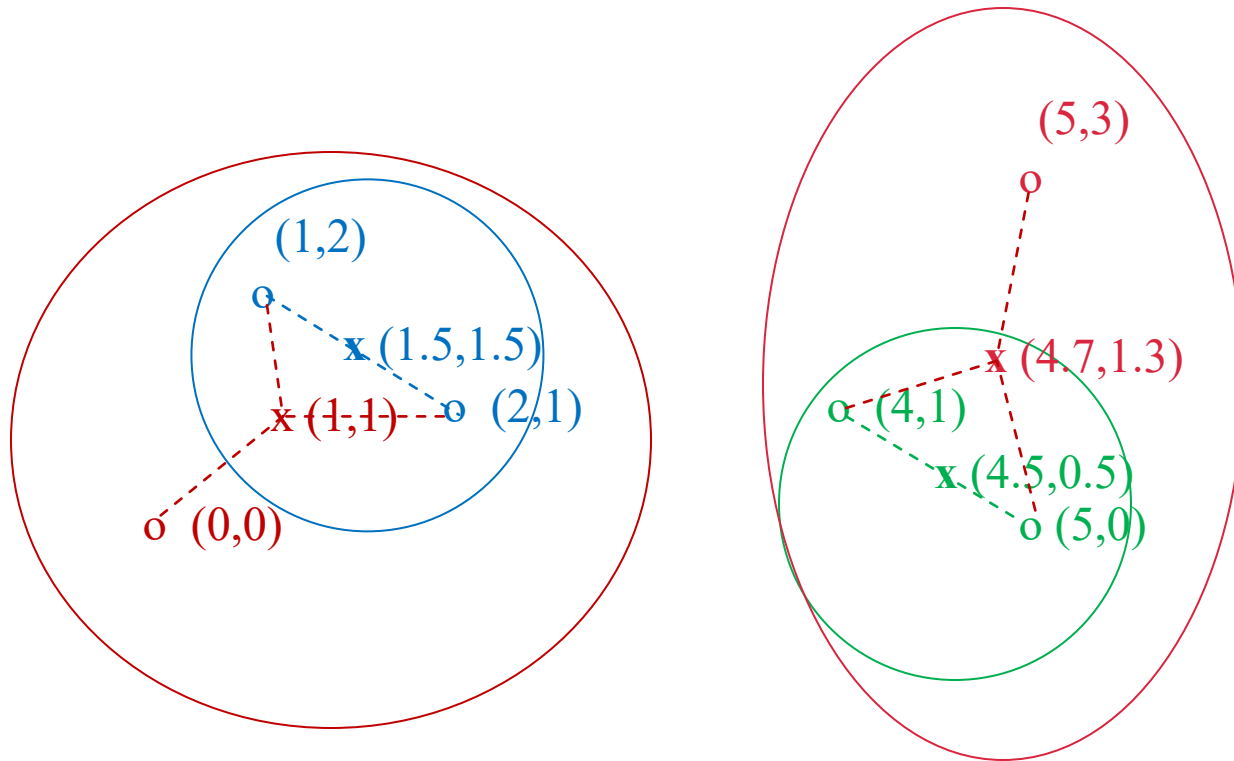

**Data:**

$o$  ... data point

$x$  ... centroid

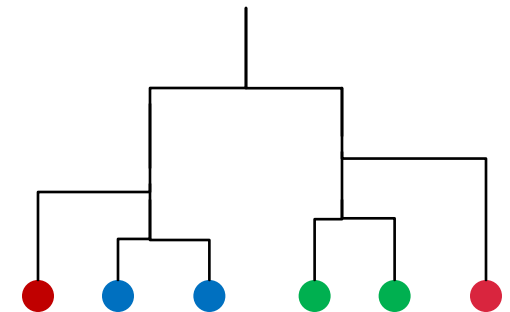

**Dendrogram**

# Hierarchical Clustering: Non-Euclidean

## In non-Euclidean case:

- The only “locations” we can talk about are the points themselves. There are three main approaches:

### (1) How to represent a cluster of many points?

1. pick a *clustroid* = point “closest” to other points
- 2,3. As the collection of points it is.

### (2) How to determine the nearness of clusters?

1. Treat clustroid as if it were centroid
2. Various distance measures between points of two clusters
3. Various cohesion measures of the union of two clusters

# Hierarchical Clustering: Non-Euclidean

## Approach 1:

### (1) How to represent a cluster:

- pick a **clustroid** = (data)point “closest” to other points

#### Possible meanings of “closest”:

- Smallest maximum distance to other points
- Smallest average distance to other points
- Smallest sum of squares of distances to other points

- For distance metric  $d$  clustroid  $c$  of cluster  $C$  is  
$$\arg \min_c \sum_{x \in C} d(x, c)^2$$

### (2) How to determine the nearness of clusters?

- Treat clustroid as if it were centroid

# Centroid vs Clustroid

- **Centroid** is the avg. of all (data)points in the cluster.
  - This means centroid is an “artificial” point.
- **Clustroid** is an **existing** (data)point that is “closest” to all other points in the cluster.

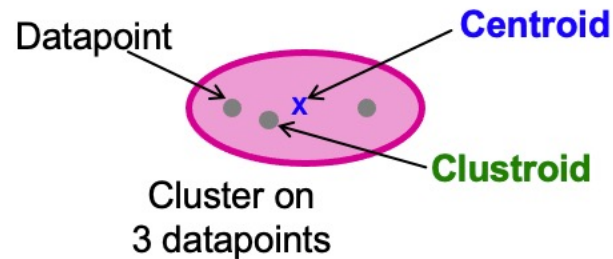



# Hierarchical Clustering: Non-Euclidean

## Approach 2:

**(1) How to represent a cluster?** As the collection of points it is

**(2) How to determine the nearness of clusters?**

Define *inter-cluster distance*:

- Minimum of the distances between any two points, one from each cluster
- Average distance of all pairs of points, one from each cluster

# Hierarchical Clustering: Non-Euclidean

## Approach 3:

**(1) How to represent a cluster?** As the collection of points it is

**(2) How to determine the nearness of clusters?**

Define a notion of *cohesion*, and merge clusters whose *union* is most cohesive

Possible notions of cohesion (the smaller, the more cohesive):

- **diameter** of the merged cluster = maximum distance between points in the cluster
- **average distance** between points in the cluster
- **Density** of the merged cluster = divide by the number of points in the cluster by diameter or avg. distance

# When to Stop?

## (3) When do we stop merging clusters?

- When some number  $k$  of clusters are found (assumes we know the number of clusters)
- When stopping criterion is met
  - Stop if diameter exceeds threshold
  - Stop if density is below some threshold
  - Stop if merging clusters yields a bad cluster
    - E.g., diameter suddenly jumps
- Keep merging until there is only 1 cluster left

# Which design choice is the best?

- It really depends on the shape of clusters.
  - Which you may not know in advance.
- **Example:** we'll compare two approaches:
  1. Merge clusters with smallest distance between centroids (or clustroids for non-Euclidean)
  2. Merge clusters with the smallest distance between two points, one from each cluster

# Case 1: Convex Clusters

- Centroid-based merging works well.
- But merger based on closest members might accidentally merge incorrectly.

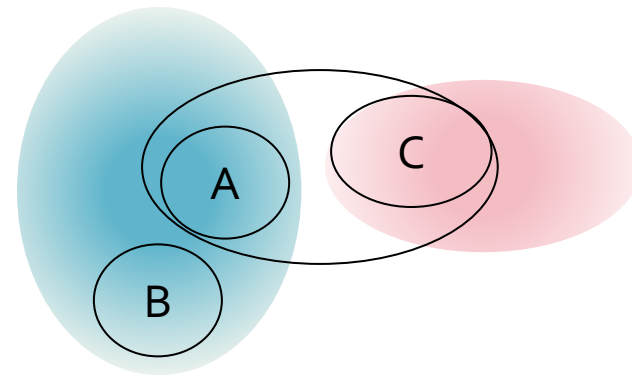

A and B have closer centroids than A and C, but closest points are from A and C.

 Data density

# Case 2: Concentric Clusters

- Linking based on closest members works well
- But Centroid-based linking might cause errors

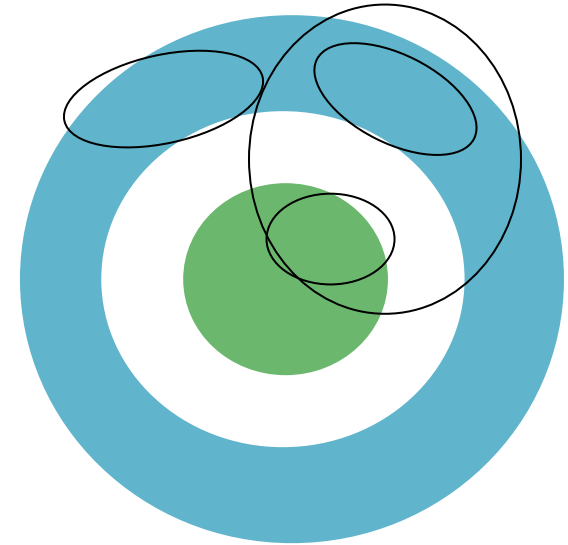

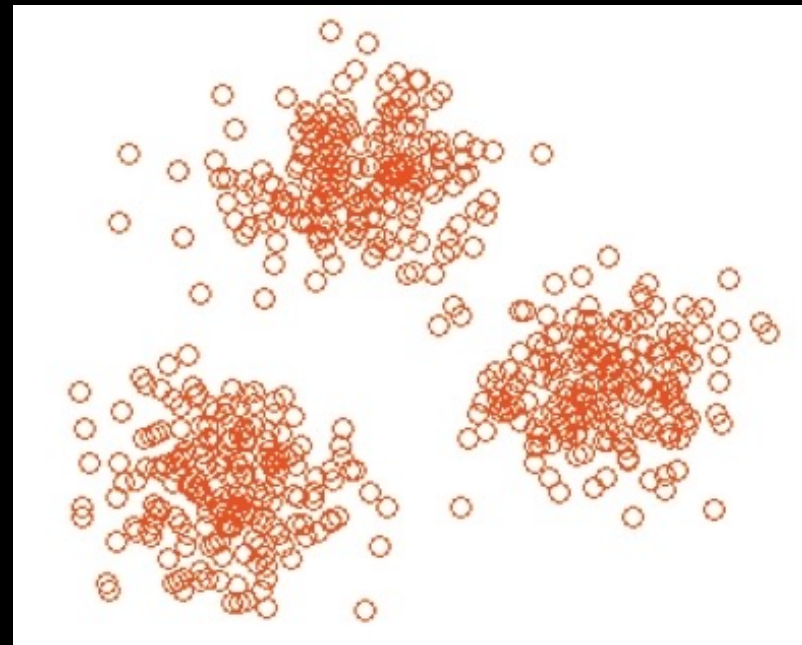

# *k*-means Clustering

# *k*-means Algorithm(s)

- It is a problem formulation, not an algorithm.
- **Problem:** Given Euclidean space/distance and  $k$  = number of clusters, find cluster centers that minimizes sum of squared distances from each point to its cluster center
- Finding an exact solution is NP-hard.
- The approximate solution is **Lloyd's algorithm** or the ***k*-means algorithm**.



# $k$ -means Algorithm(s)

- Initialize clusters by picking  $k$  centers

## Until convergence:

- **1)** For each point, assign it to the cluster whose current centroid is the closest
- **2)** After all points are assigned, update the centroids of the  $k$  clusters as **average of datapoints within each cluster**

**Convergence means** Points don't move between clusters and centroids stabilize

# Shortcoming of k-means

Convergence of k-means heavily depends on the initial pick of centroids. It can perform arbitrarily bad.



- Different strategies for picking k centers:
  - Pick k datapoints at random
  - K-means ++

# k-Means++

- **Basic idea:** Pick a small sample of points  $S$ , cluster them by any algorithm, and use the centroids as a seed
- In **k-means++**, sample size  $|S| = k$  times a factor that is logarithmic in the total number of points
- **How to pick sample points:** Visit points in random order, but the probability of adding a point  $p$  to the sample is proportional to  $D(p)^2$ .
  - $D(p)$  = distance between  $p$  and the nearest already picked point.

# Example: Assigning Clusters

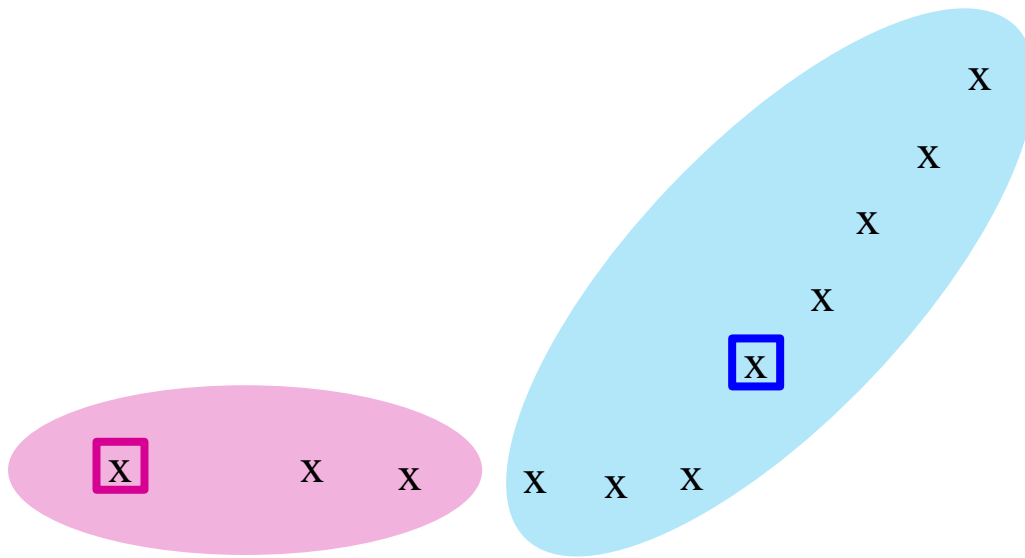

x ... data point  
□ ... centroid

**Clusters after round 1**

# Example: Assigning Clusters

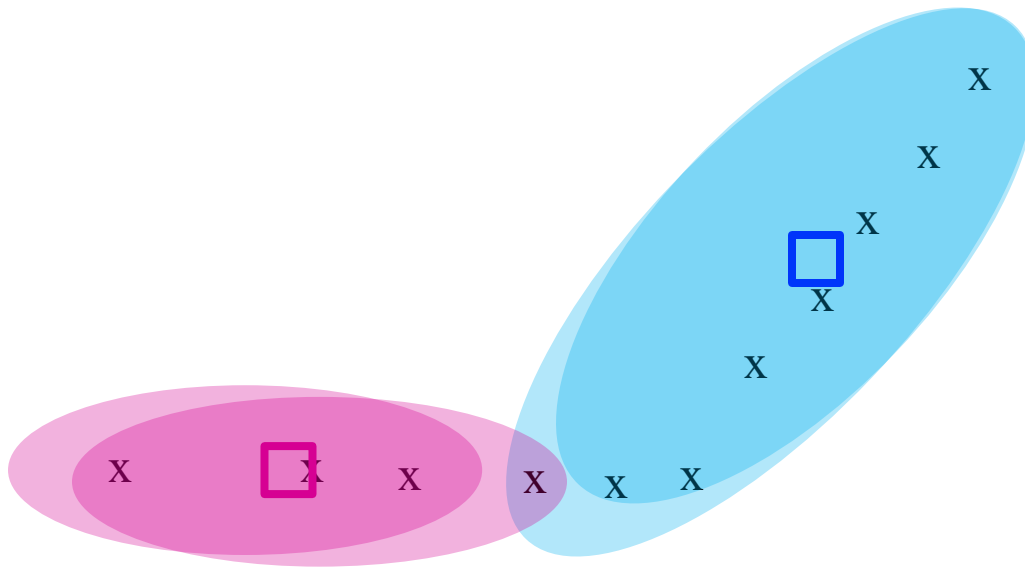

x ... data point  
□ ... centroid

**Clusters after round 2**

# Example: Assigning Clusters

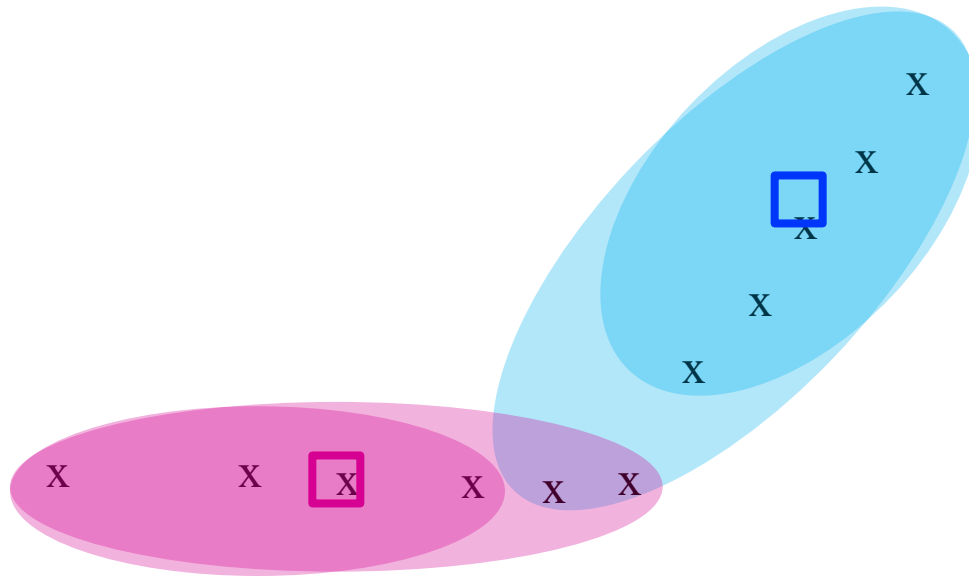

x ... data point  
□ ... centroid

**Clusters at the end**

# Getting the $k$ right

## How to select $k$ ?

- Try different  $k$ , looking at the change in the average distance to centroid as  $k$  increases
- Average falls rapidly until right  $k$ , then changes little

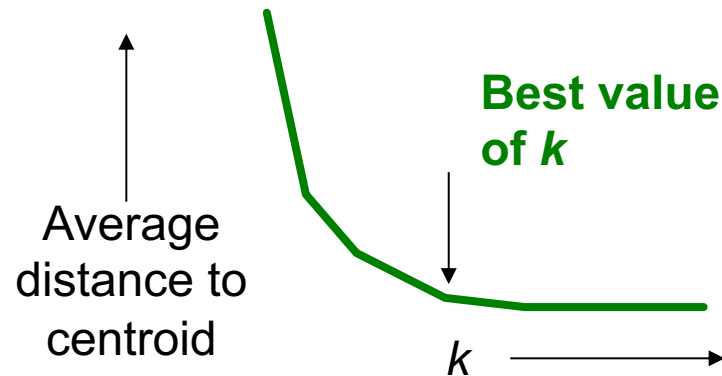

# Example: Picking $k$

Too few;  
many long  
distances  
to centroid

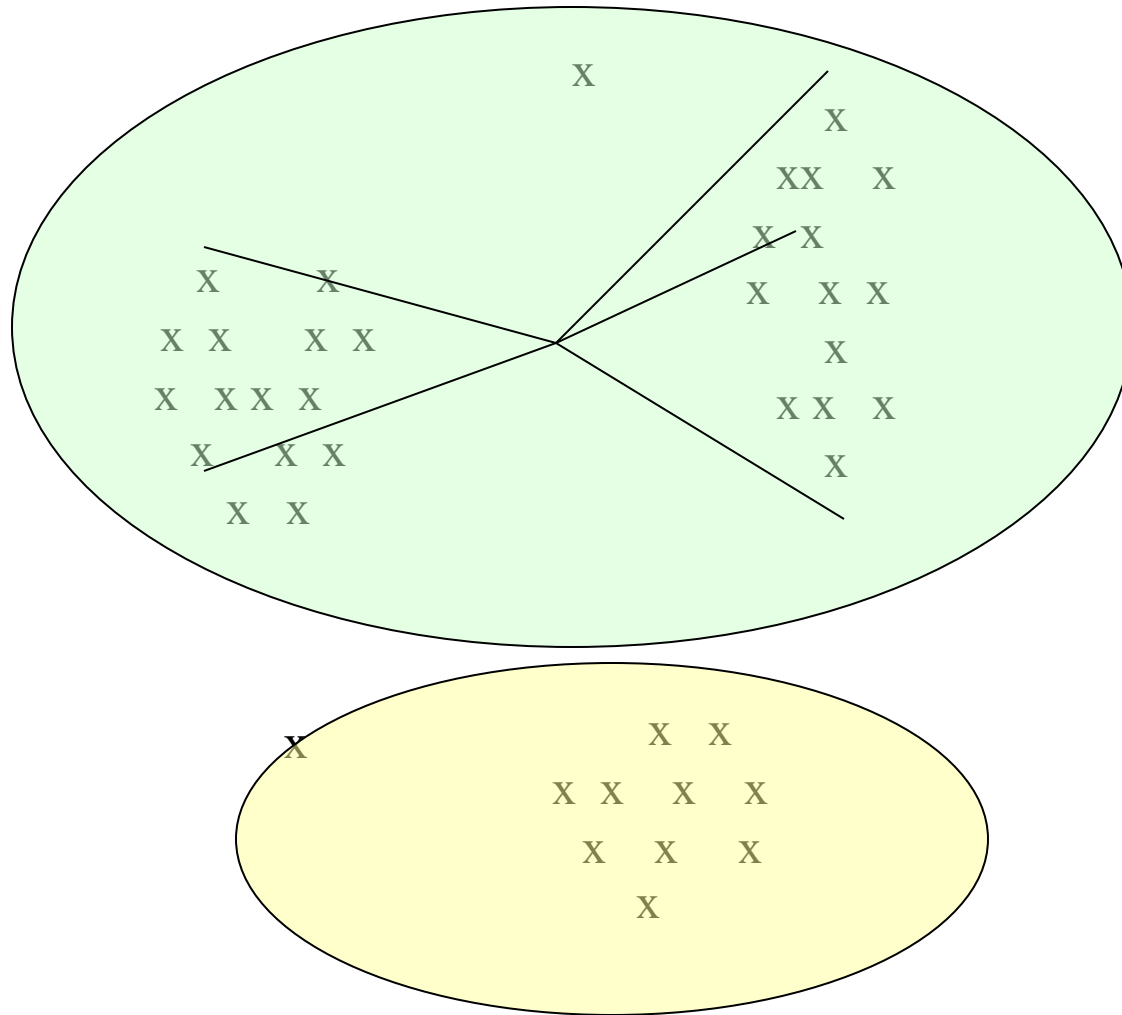



# Example: Picking $k$

Just right;  
distances  
rather short

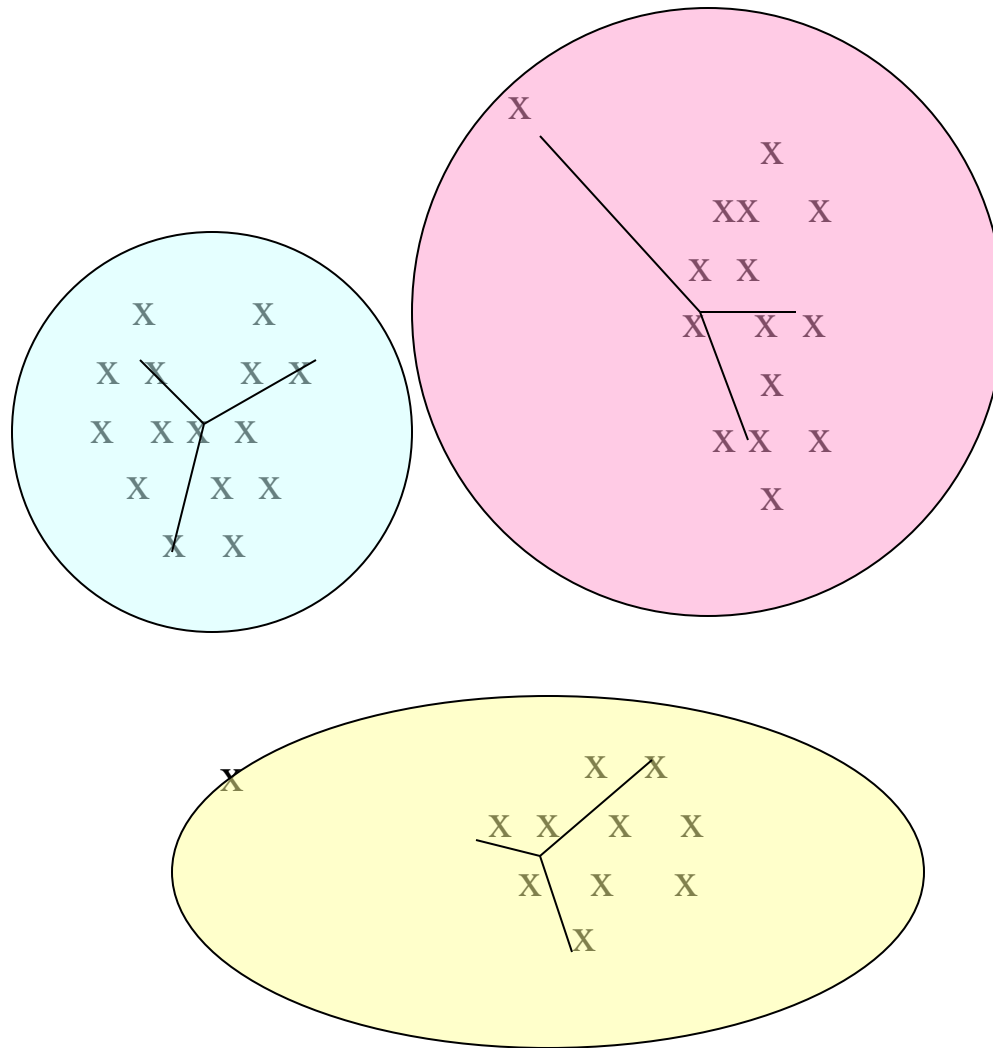

# Example: Picking $k$

Too many;  
little improvement  
in average  
distance

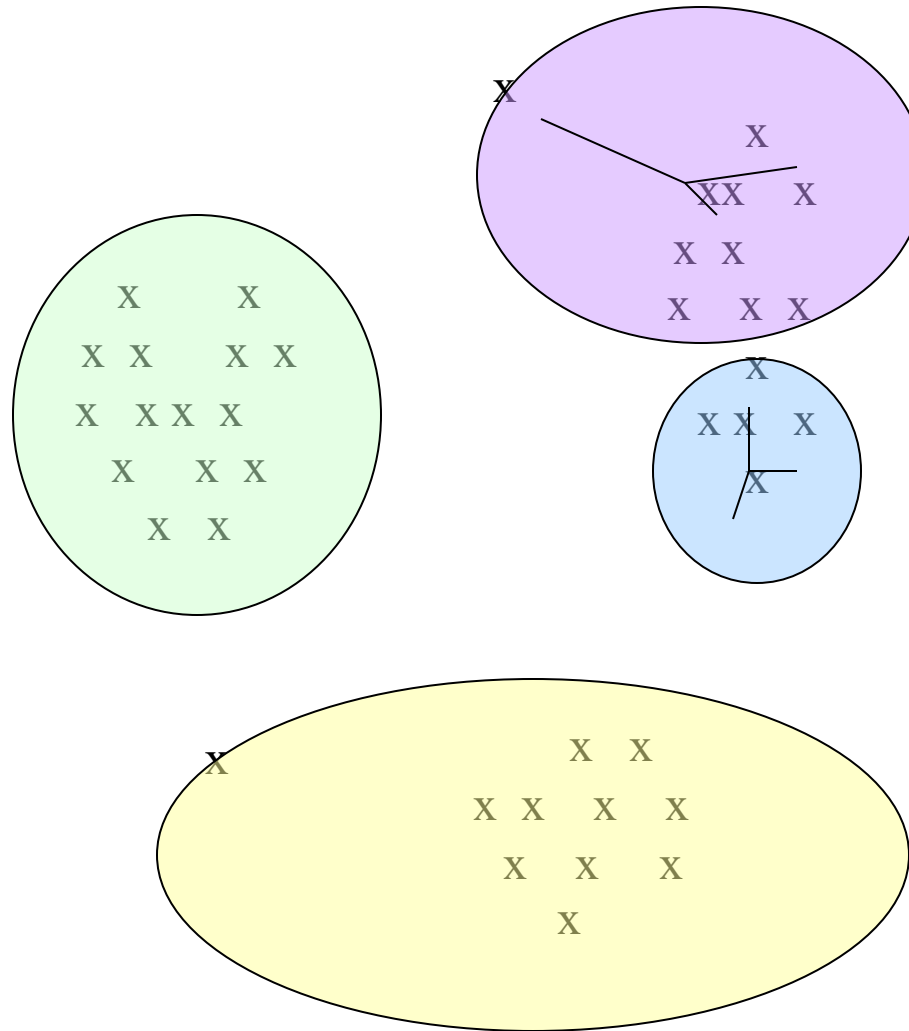

# The BFR Algorithm

Extension of *k*-means to large data

# BFR Algorithm

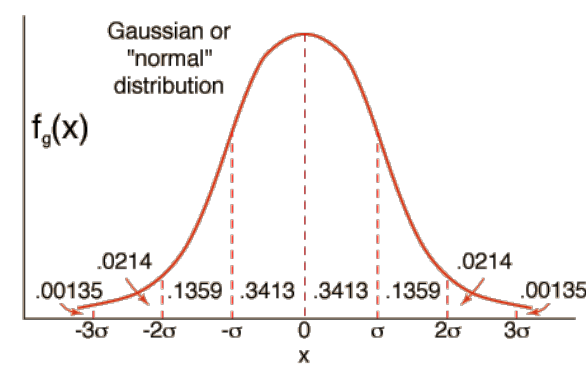

- **BFR** [Bradley-Fayyad-Reina] is a variant of  $k$ -means designed to handle **very large** (disk-resident) data sets
- **Assumes** that clusters are normally distributed around a centroid in a Euclidean space
  - Standard deviations in different dimensions may vary
    - Clusters are axis-aligned ellipses
- Goal is to find cluster centroids; point assignment can be done in a second pass through the data.

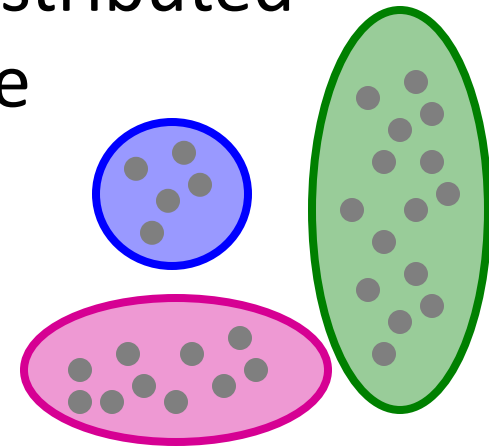

# BFR Overview

- **Efficient way to summarize clusters:** Want memory required  $O(\text{clusters})$  and not  $O(\text{data})$
- **IDEA: Rather than keeping points, BFR keeps summary statistics of groups of points**
  - 3 sets: Discard set, Compressed set, Retained set
- **Overview of the algorithm:**
  - 1. Initialize  $K$  clusters/centroids
  - 2. Load in a bag of points from disk
  - 3. Assign new points to one of the  $K$  original clusters, if they are within some distance threshold of the cluster
  - 4. Cluster the remaining points, and create new clusters
  - 5. Try to merge new clusters from step 4 with any of the existing clusters
  - 6. Repeat steps 2-5 until all points are examined

# BFR Algorithm

- Points are read from disk one main-memory-full at a time
- Most points from previous memory loads are summarized by **simple statistics**
- **Step 1)** From the initial load we select the initial  $k$  centroids by some sensible approach:
  - Take  $k$  random points
  - Take a small random sample and cluster optimally
  - Take a sample; pick a random point, and then  $k-1$  more points, each as far from the previously selected points as possible

# Three Classes of Points

## 3 sets of points which we keep track of:

- **Discard set (DS):**
  - Points close enough to a centroid to be summarized
- **Compressed set (CS):**
  - Groups of points that are close together but not close to any existing centroid
  - These points are summarized, but not assigned to a cluster
- **Retained set (RS):**
  - Isolated points waiting to be assigned to a compressed set

# BFR: "Galaxies" Picture

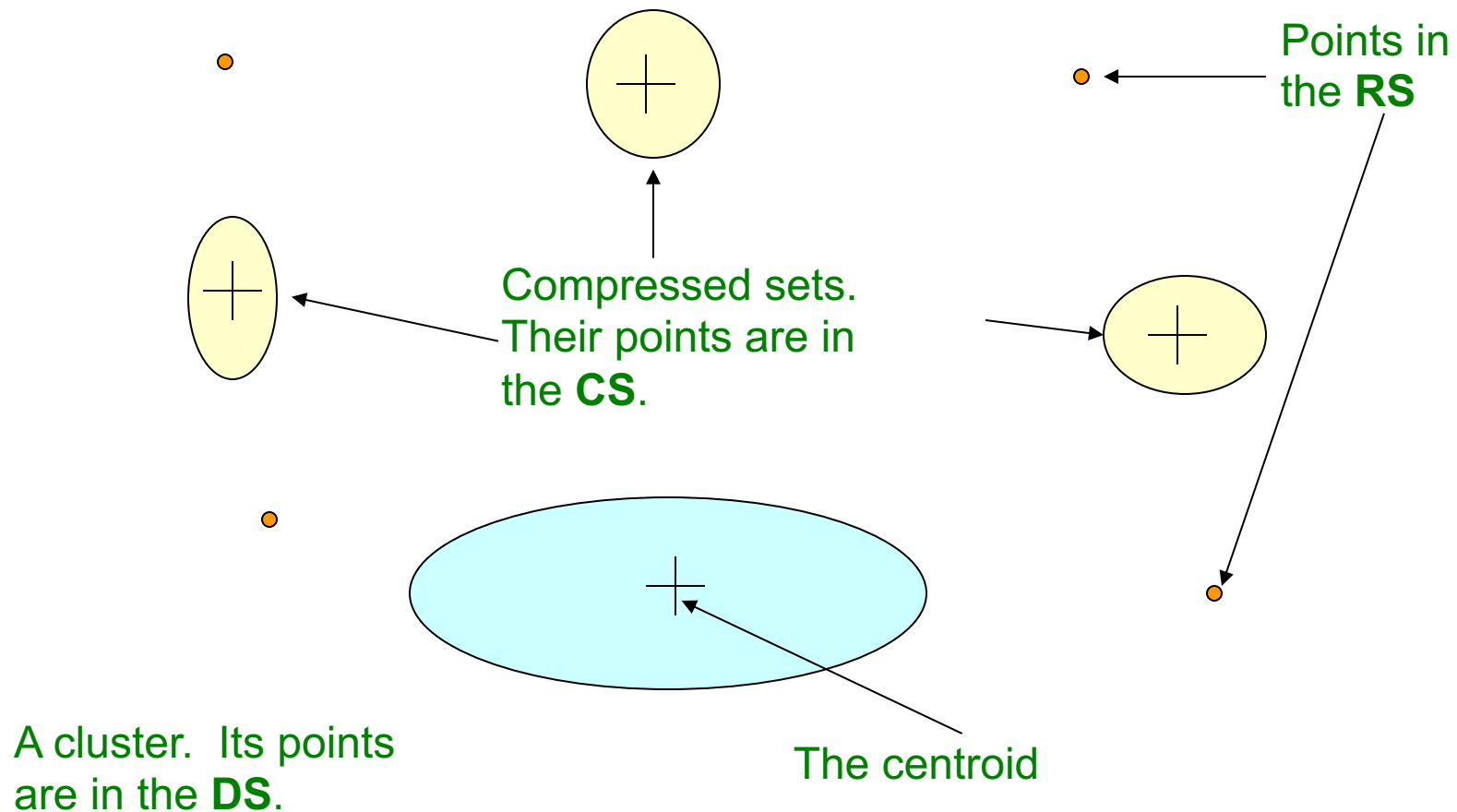

**Discard set (DS):** Close enough to a centroid to be summarized  
**Compression set (CS):** Summarized, but not assigned to a cluster  
**Retained set (RS):** Isolated points, we store them as they are



# Summarizing Sets of Points

For each cluster, the discard set (DS) is summarized by:

- The number of points,  $N$
- The vector  $SUM$ , whose  $i^{\text{th}}$  component is the sum of the coordinates of the points in the  $i^{\text{th}}$  dimension
- The vector  $SUMSQ$ :  $i^{\text{th}}$  component = sum of squares of coordinates in  $i^{\text{th}}$  dimension

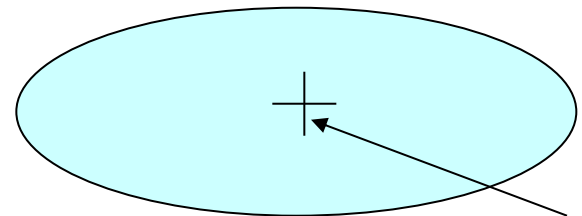

A cluster.

All its points are in the **DS**.

The centroid

# Summarizing Points: Comments

- $2d + 1$  values represent any size cluster
  - $d$  = number of dimensions
- Average in **each dimension** (**the centroid**) can be calculated as  $\text{SUM}_i / N$ 
  - $\text{SUM}_i = i^{\text{th}}$  component of SUM
- Variance of a cluster's discard set in dimension  $i$  is:  $(\text{SUMSQ}_i / N) - (\text{SUM}_i / N)^2$ 
  - And standard deviation is the square root of that
- **Next step: Actual clustering**

**Note:** Dropping the “axis-aligned” clusters assumption would require storing full covariance matrix to summarize the cluster. So, instead of **SUMSQ** being a  $d$ -dim vector, it would be a  $d \times d$  matrix, which is too big!

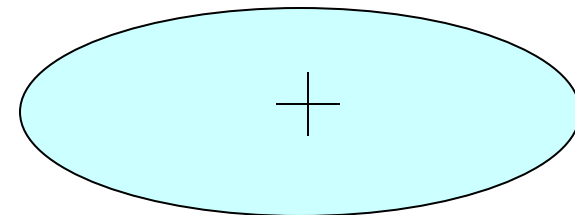

# The “Memory-Load” of Points

## Steps 3-5) Processing “Memory-Load” of points:

- **Step 3)** Find those points that are “**sufficiently close**” to a cluster centroid and add those points to that cluster and the **DS**
  - These points are so close to the centroid that they can be summarized and then discarded
- **Step 4)** Use any in-memory clustering algorithm to cluster the remaining points and the old **RS**
  - Clusters go to the **CS**; outlying points to the **RS**

**Discard set (DS):** Close enough to a centroid to be summarized.

**Compression set (CS):** Summarized, but not assigned to a cluster

**Retained set (RS):** Isolated points

# The “Memory-Load” of Points

## Steps 3-5) Processing “Memory-Load” of points:

- **Step 5) DS set:** Adjust statistics of the clusters to account for the new points
  - Add  $N_s$ ,  $SUM_s$ ,  $SUMSQ_s$
  - Consider merging compressed sets in the **DS**
- **If this is the last round**, merge all compressed sets in the **CS** and all **RS** points into their nearest cluster

**Discard set (DS):** Close enough to a centroid to be summarized.

**Compression set (CS):** Summarized, but not assigned to a cluster

**Retained set (RS):** Isolated points

# Summary: BFR

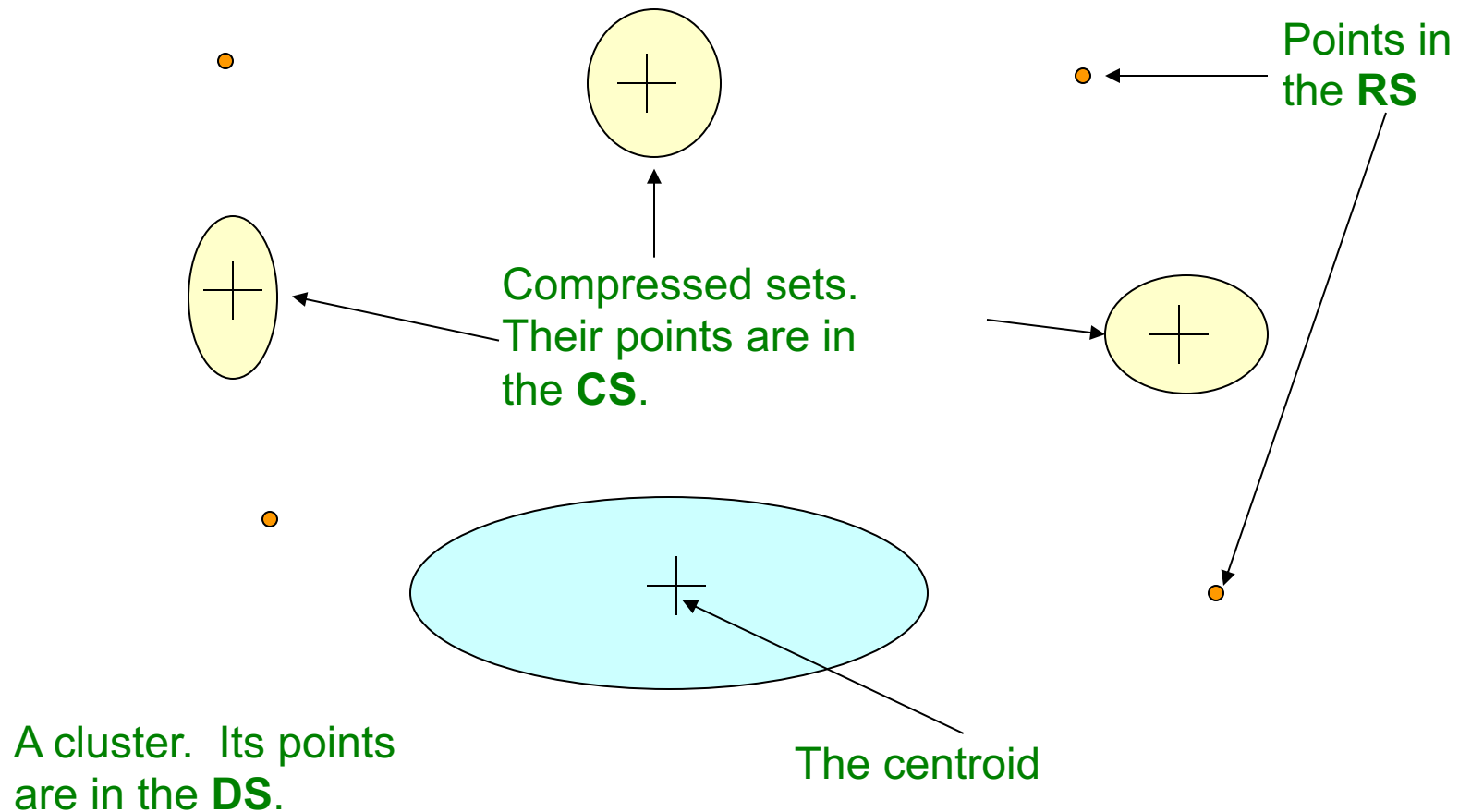

**Discard set (DS):** Close enough to a centroid to be summarized  
**Compression set (CS):** Summarized, but not assigned to a cluster  
**Retained set (RS):** Isolated points

# A Few Details...

- **Q1)** How do we decide if a point is “close enough” to a cluster that we will add the point to that cluster?
- **Q2)** How do we decide whether two compressed sets (CS) deserve to be combined into one?

# How Close is Close Enough?

- **Q1)** We need a way to decide whether to put a new point into a cluster (and discard)
- **BFR** suggests two ways:
  - The **Mahalanobis distance** is less than a threshold
  - High likelihood of the point belonging to currently nearest centroid

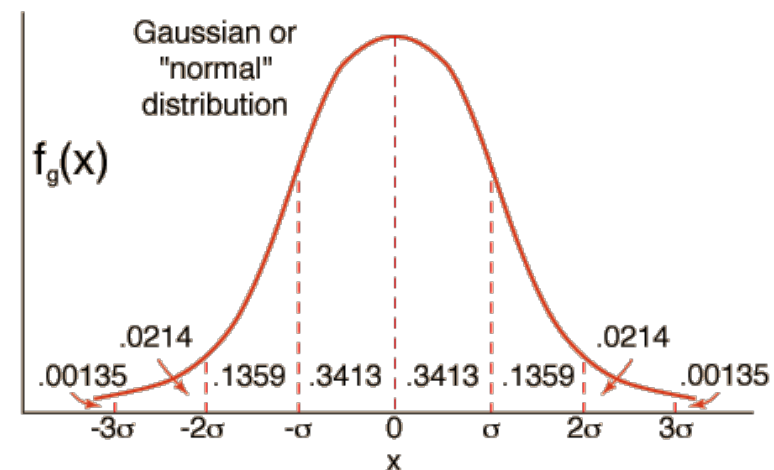

# Mahalanobis Distance

- **Normalized Euclidean distance from centroid**
- For a given point  $(x_1, \dots, x_d)$  and a given centroid  $(c_1, \dots, c_d)$ 
  1. Normalize in each dimension:  $y_i = (x_i - c_i) / \sigma_i$
  2. Take sum of the squares of the  $y_i$
  3. Take the square root

$$d(x, c) = \sqrt{\sum_{i=1}^d \left( \frac{x_i - c_i}{\sigma_i} \right)^2}$$

$\sigma_i$  ... standard deviation of points in the cluster in the  $i^{\text{th}}$  dimension



# Mahalanobis Distance

- If clusters are normally distributed in  $d$  dimensions, then after transformation, one standard deviation =  $\sqrt{d}$ 
  - i.e., 68% of the points of the cluster will have a Mahalanobis distance  $< \sqrt{d}$
- Accept a point for a cluster if its M.D. is  $<$  some threshold, e.g. **2** standard deviations

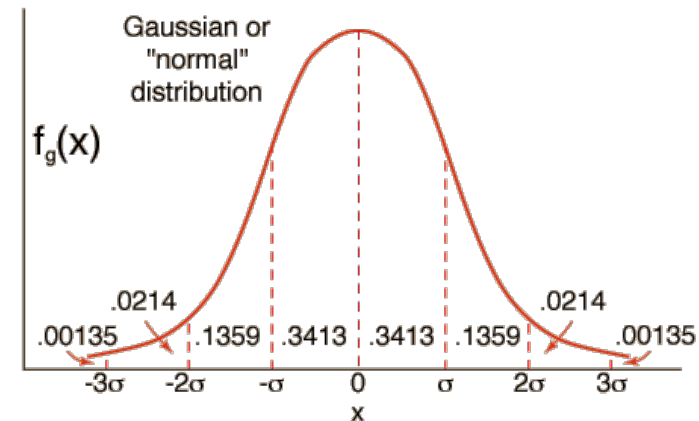

# Picture: Equal M.D. Regions

## ■ Euclidean vs. Mahalanobis distance

Contours of equidistant points from the origin

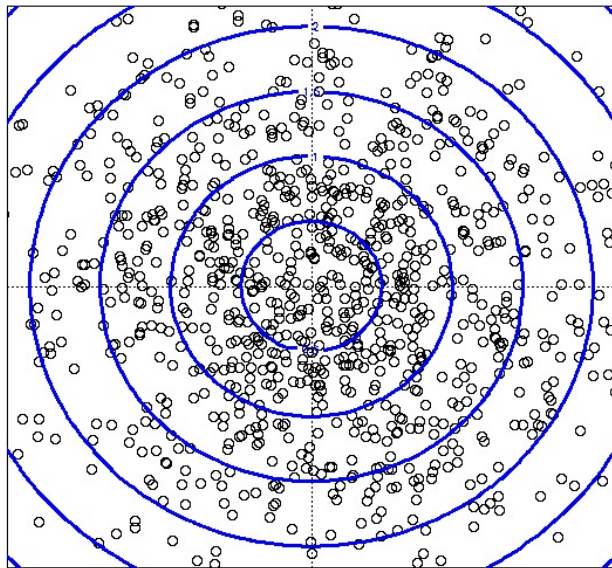

Uniformly distributed points,  
Euclidean distance

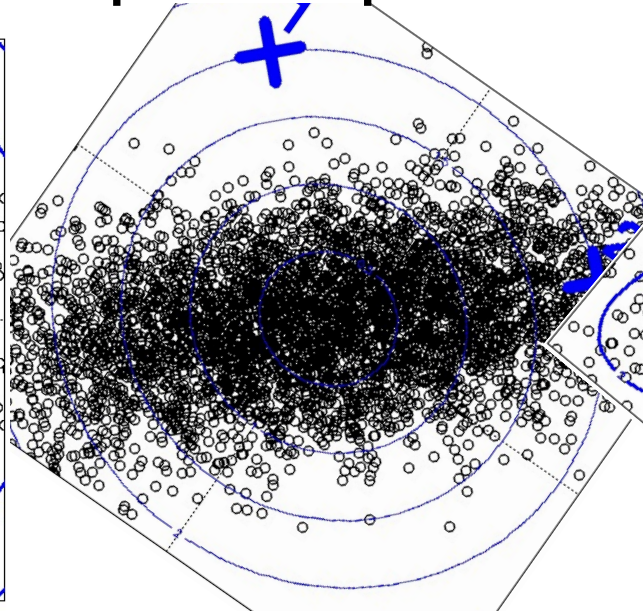

Normally distributed points,  
Euclidean distance

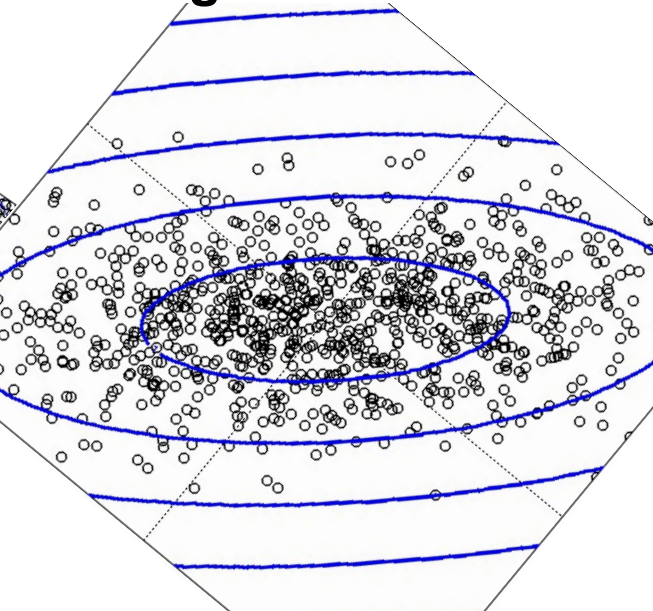

Normally distributed points,  
Mahalanobis distance

# Should 2 CS clusters be combined?

## Q2) Should 2 CS clusters be combined?

- Compute the variance of the combined subcluster
  - $N$ ,  $SUM$ , and  $SUMSQ$  allow us to make that calculation quickly
- Combine if the combined variance is below some threshold
- **Many alternatives:** Treat dimensions differently, consider density

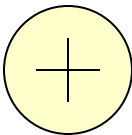
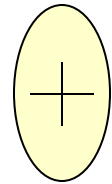

# The CURE Algorithm

Extension of *k*-means to clusters of arbitrary shapes

# CURE Algorithm

- **CURE (Clustering Using REpresentatives):**
  - Assumes a Euclidean distance
  - No assumption about shape of clusters
    - No need to be normally distributed in each dim
    - No need to have fixed axis
  - Instead of centroid, uses a collection of representative points to represent clusters
  - Assumes  $k$ =number of clusters is given
- In contrast, BFR and  $k$ -means assume:
  - clusters are normally distributed in each dimension
  - Axes are fixed – ellipses at an angle are **not** OK

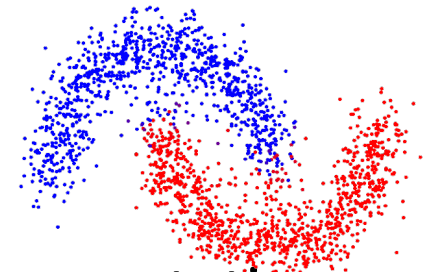

# Example: Stanford Salaries

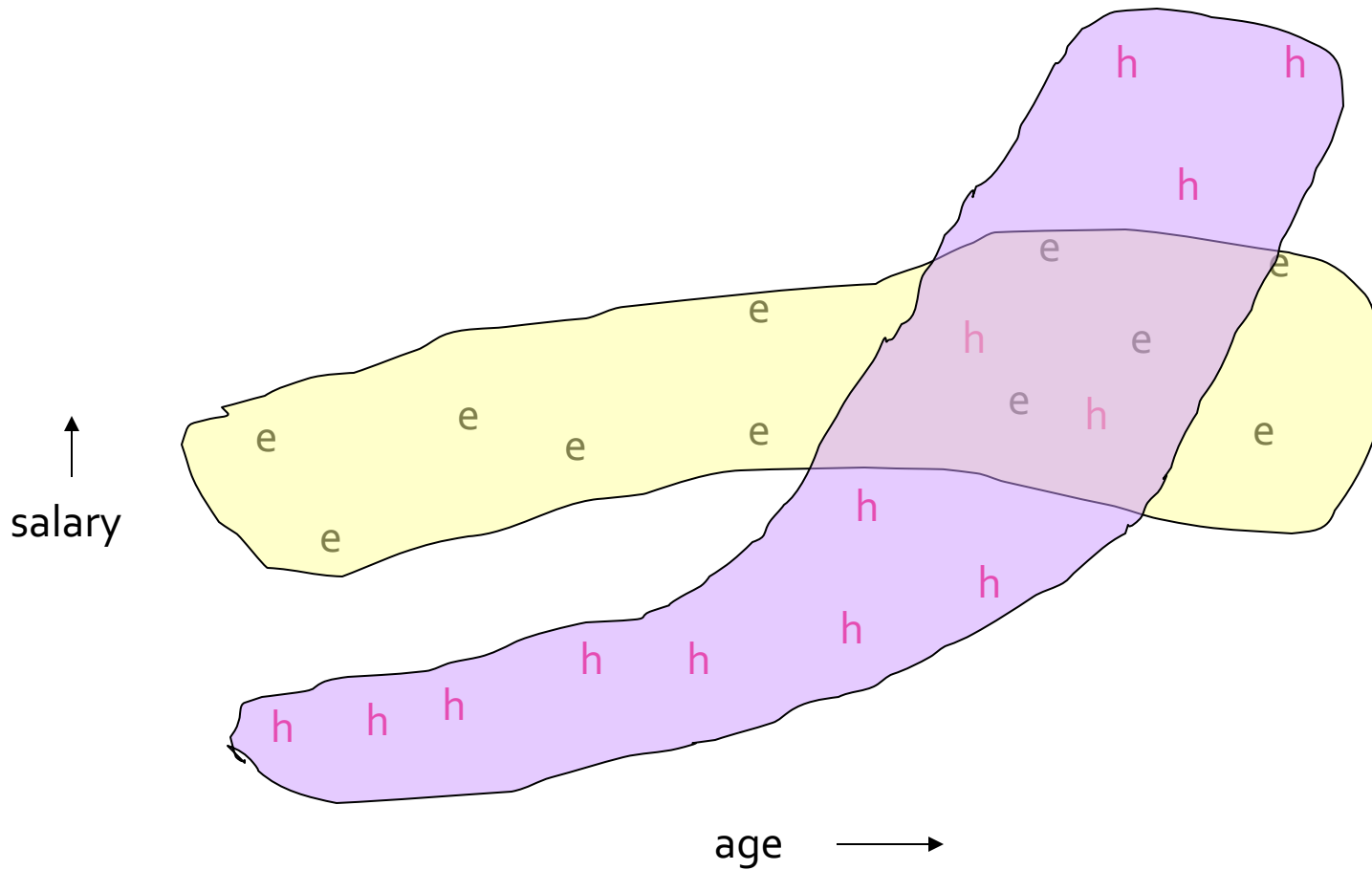

# Starting CURE

## 2 Pass algorithm. Pass 1:

- Pick a random sample of data and cluster them in main memory using hierarchical clustering
  - merge two clusters when they have close pair of points
- Pick representative points from each cluster
  - For each cluster, pick a sample of points, as dispersed as possible
  - move representatives a fraction of distance e.g. 20% toward the centroid of the cluster
  - Merge clusters with the closest pair of representatives

# Example: Initial Clusters

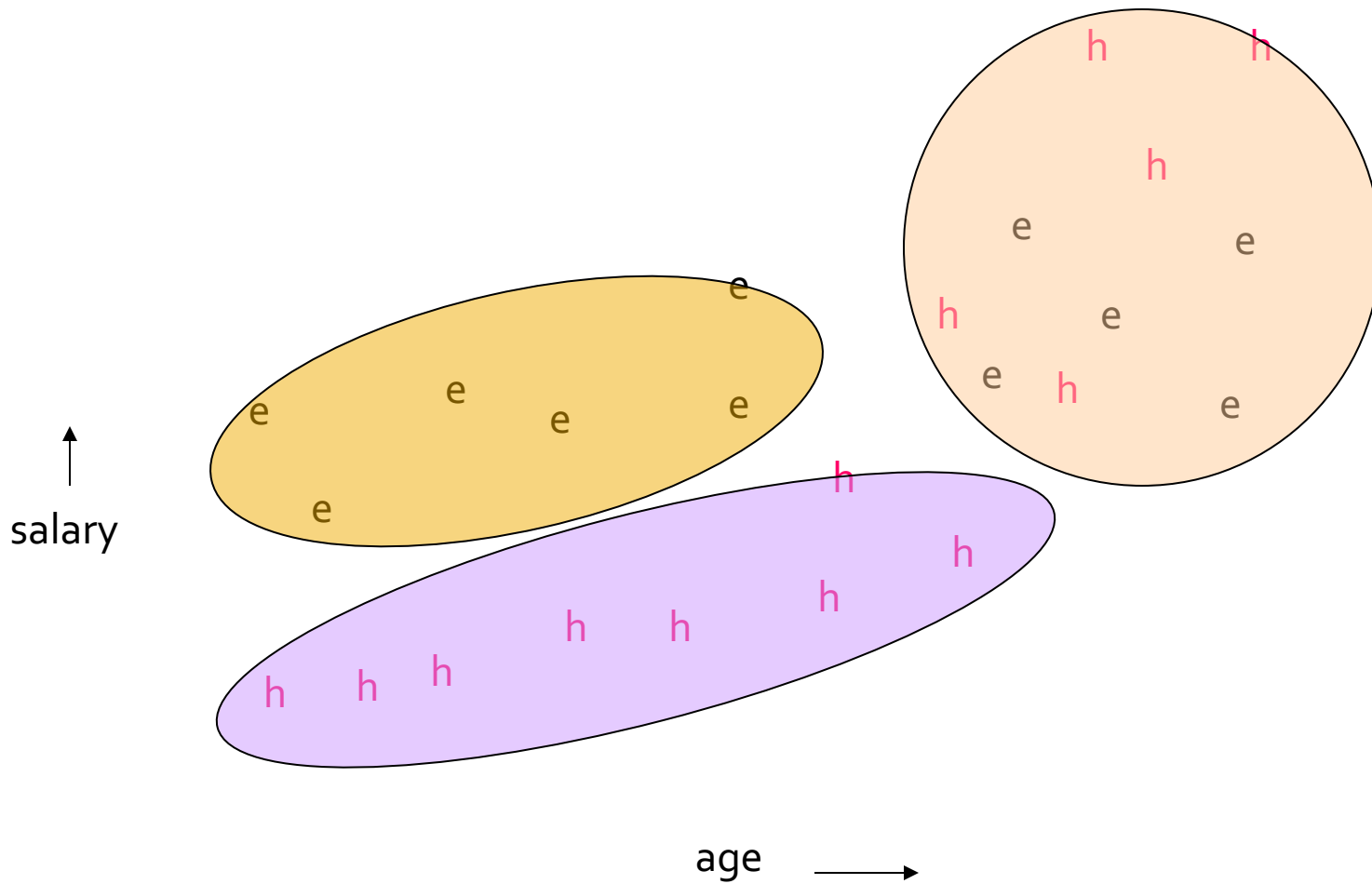



# Example: Pick Dispersed Points

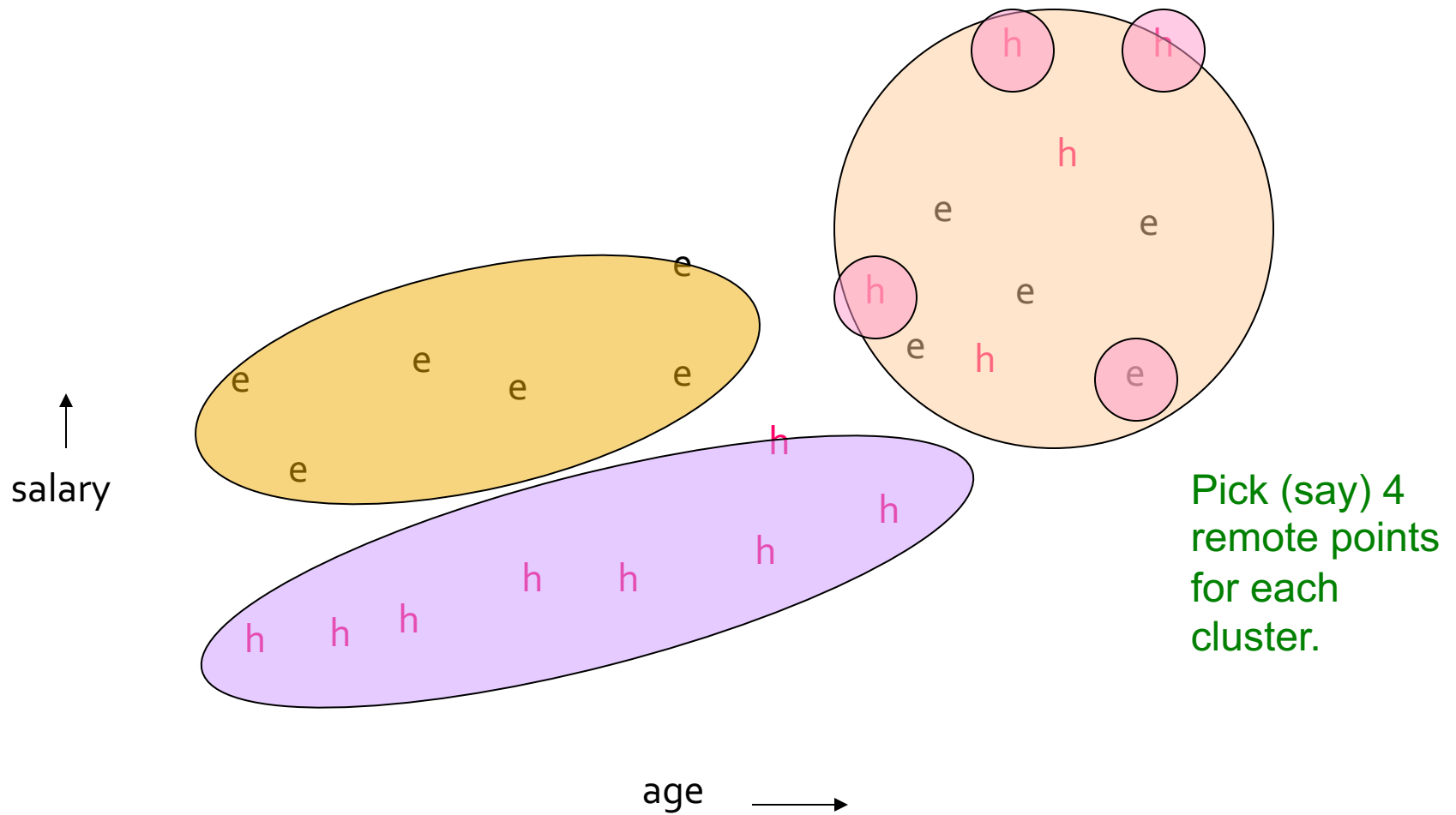

# Example: Pick Dispersed Points

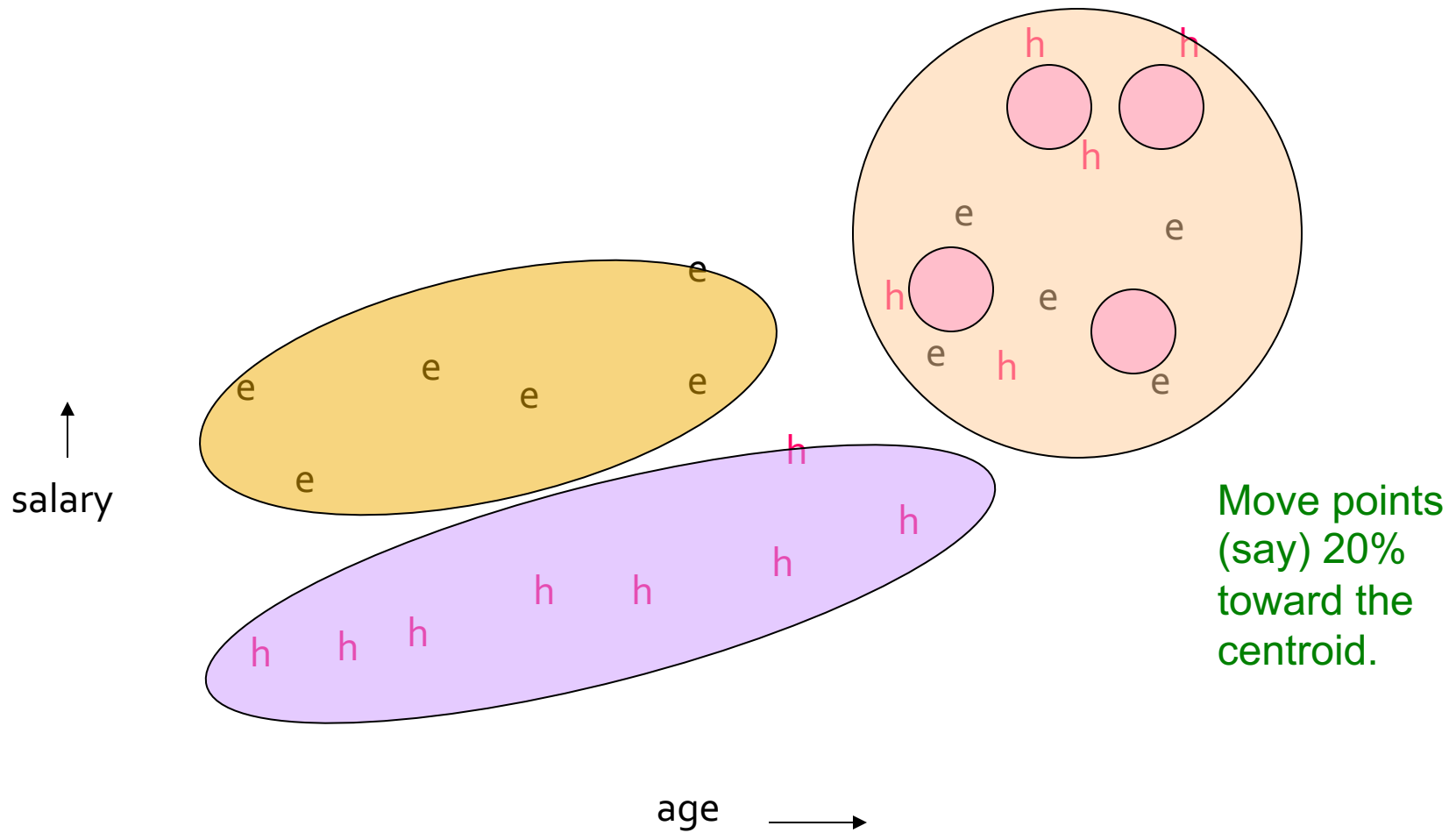

# Finishing CURE

## Pass 2:

- Now, rescan the whole dataset and visit each point  $p$  in the data set
- Place it in the “closest cluster”
  - Normal definition of “closest”:  
Find the closest representative point to  $p$  and assign it to representative’s cluster

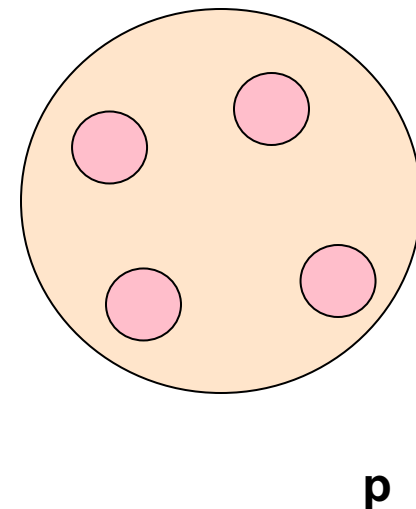

# Why the 20% Move Inward?

## Intuition:

- If initial sample is *large* enough, some of the representatives will be on the *boundary* of clusters
  - Moving them towards centroid, move them inside
- A large, dispersed cluster will have larger moves as opposed to a small, dense cluster
  - Favors a small, dense cluster that is near a larger dispersed cluster



# Summary

- **Clustering:** Given a **set of points**, with a notion of **distance** between points, **group the points** into some number of *clusters*
- **Algorithms:**
  - Agglomerative **hierarchical clustering:**
    - Centroid and clustroid
  - **k-means:**
    - Initialization, picking  $k$
  - **BFR**
  - **CURE**